

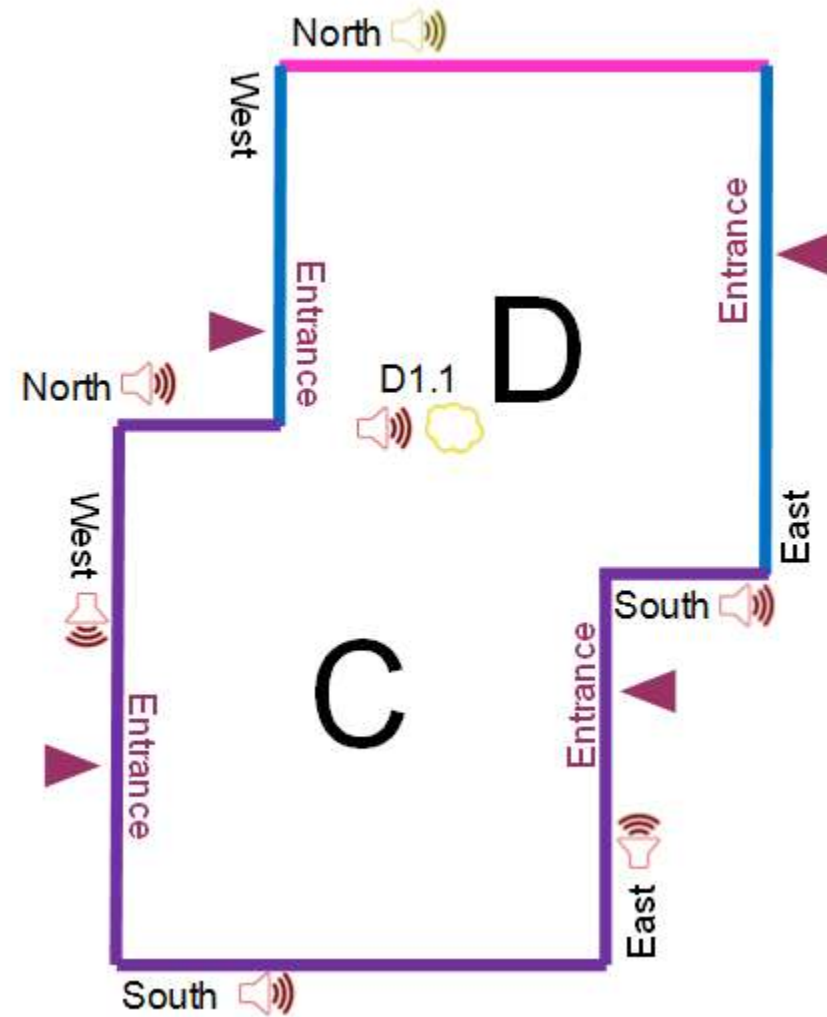









# LAFROWDA blocks C & D–Planned external works taking place week commencing Monday 3 December



## Key

	High dust		Building outline
	Medium dust		Construction works
	High noise		Scaffolding
	Medium noise		Rendering works
	No works planned		Installation of boards

### Block C

- Installation of boards to the exterior of the building on all sides of the block throughout the week, some localised high noise expected

### Block D

- Installation of boards to the exterior of the building on the south side of the block throughout the week, some localised high noise expected
- Exterior works taking place on the north, east and west sides of the block throughout the week
- Scaffolding will be removed from the north side of the block from Thursday onwards
- Localised internal high noise expected on Monday and Tuesday as work starts on the shower room floors in **D1.1** - works will continue throughout the week.

**Works take place Monday-Friday 09:00-18:00**







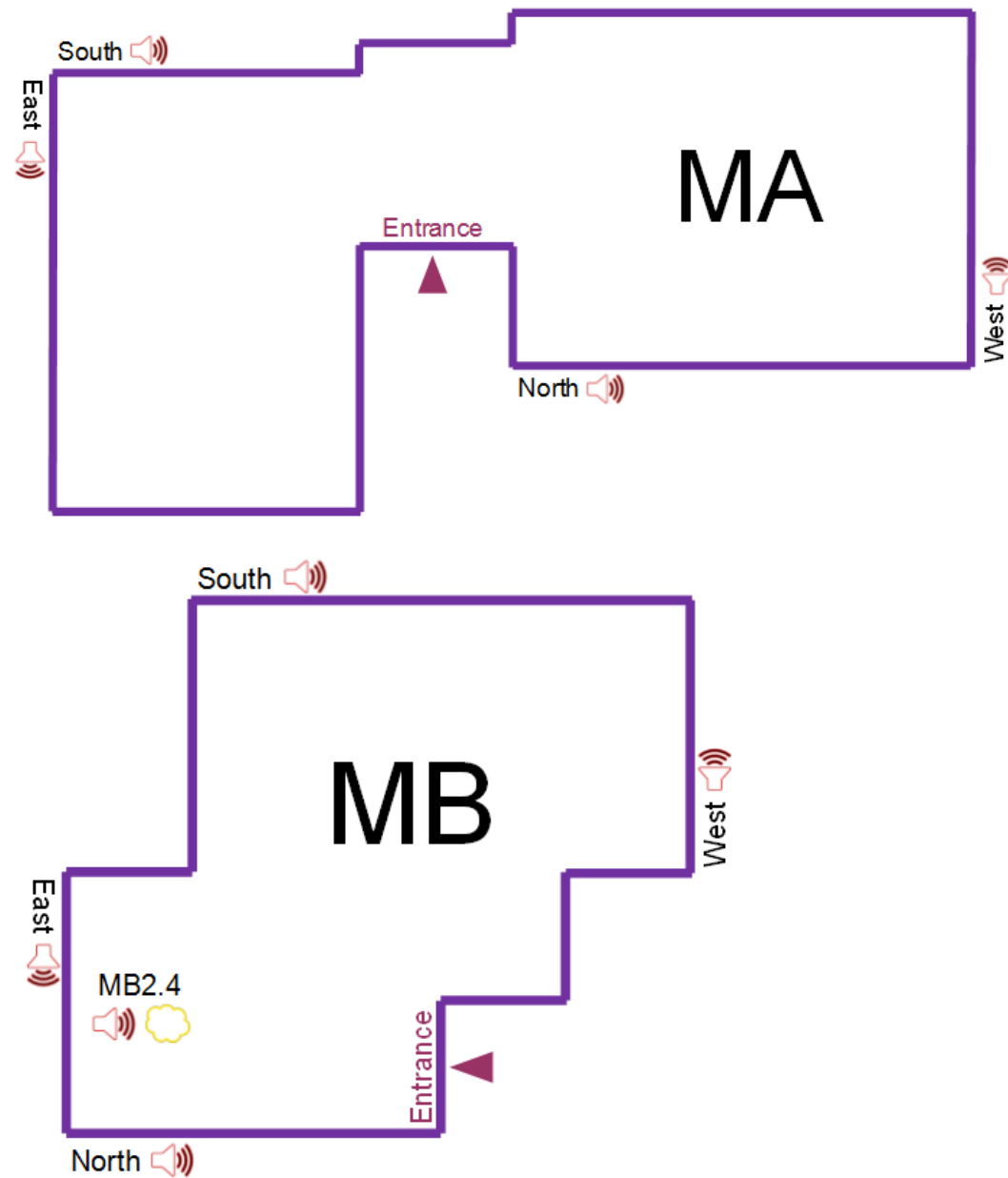



*Please note there may be unforeseen circumstances which alter the schedule above and therefore the works highlighted are subject to change.*

We would like to apologise for any inconvenience caused by our repairs and improvement works. Should you wish to speak to a member of the team please contact: [residencefeedback@exeter.ac.uk](mailto:residencefeedback@exeter.ac.uk)  
In the case of an emergency outside of normal office hours or over the weekend, please contact the Estate Patrol team on 01392 723999.

# LAFROWDA blocks MA & MB–Planned external works taking place week commencing Monday 3 December



## Key

	High dust		Building outline
	Medium dust		Construction works
	High noise		Panel removal
	Medium noise		Rendering works
	No works planned		Installation of boards

### Block MA

- Installation of boards to the exterior of the building on all sides of the block throughout the week, some localised high noise expected
- Lower window panel replacement on all sides of the block on Monday and Tuesday

### Block MB

- Installation of boards to the exterior of the building on all sides of the block throughout the week, some localised high noise expected
- Lower window panel replacement on all sides of the block on Monday and Tuesday
- Localised internal high noise expected on Monday and Tuesday as work starts on the shower room floors in **MB2.4** - works will continue throughout the week.

**Works take place Monday-Friday 09:00-18:00**

*Please note there may be unforeseen circumstances which alter the schedule above and therefore the works highlighted are subject to change.*

We would like to apologise for any inconvenience caused by our repairs and improvement works. Should you wish to speak to a member of the team please contact: [residencefeedback@exeter.ac.uk](mailto:residencefeedback@exeter.ac.uk)  
In the case of an emergency outside of normal office hours or over the weekend, please contact the Estate Patrol team on 01392 723999.